

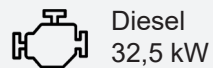

**BI-ENERGY**



Diesel  
32,5 kW



Single-phase  
Electric motor  
230VAC - 2,2 kW

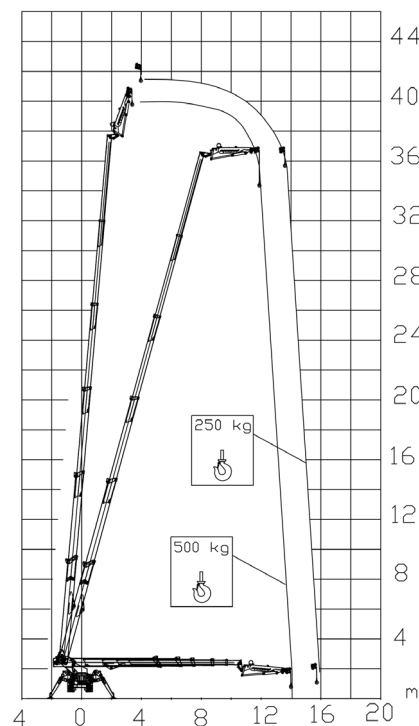

|        |        |
|--------|--------|
| 500 kg | 250 kg |
| 13,5 m | 15,2 m |

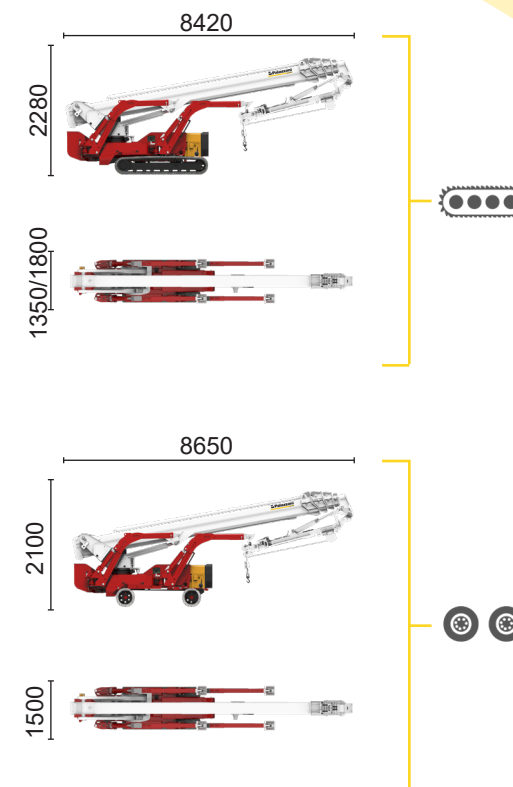

|           |  |        |        |        |      |           |         |             |     |     |          |          |       |                        |                        |
|-----------|--|--------|--------|--------|------|-----------|---------|-------------|-----|-----|----------|----------|-------|------------------------|------------------------|
| XTJ 43+/C |  | 41,7 m | 15,2 m | 500 kg | 660° | 240x70 cm | 90°+80° | 3,64-5,23 m | 23% | 38% | 2 km/h   | 10900 kg | 75 kN | 3,51 kN/m <sup>2</sup> | 5,39 kN/m <sup>2</sup> |
| XTJ 43+/R |  | 41,7 m | 15,2 m | 500 kg | 660° | 240x70 cm | 90°+80° | 3,64-5,23 m | 23% | 16% | 1,4 km/h | 10900 kg | 75 kN | 3,51 kN/m <sup>2</sup> | 5,25 kN/m <sup>2</sup> |

Available power options:

**BI-ENERGY** (DIESEL+AC)

**ECO** (AC+BATTERY)

Characteristics and technical data are informative only and subjected to change without notice.

Palazzani Industrie S.p.A.

Via del Pavione, 4 - 25050 - Paderno F.C. (BS) - Italy

Tel. (+39) 0306857073

info@palazzani.it

www.palazzani.it





**ECO**

---

 Single-phase Electric motor





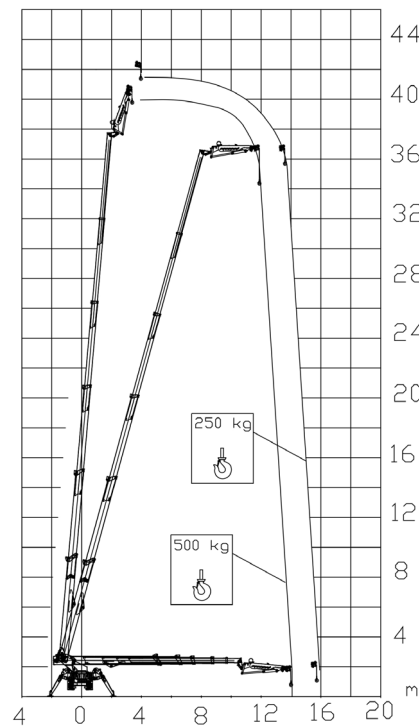



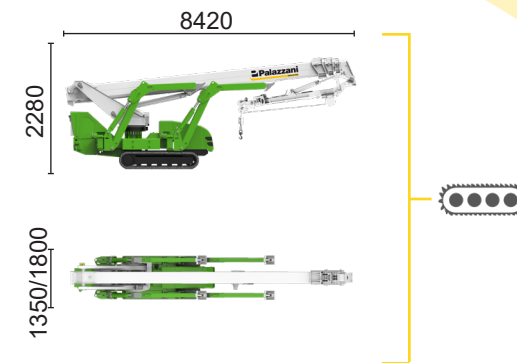





---

 Lithium iron phosphate battery LiFePO4



|        |        |
|--------|--------|
| 500 kg | 250 kg |
| 13,5 m | 15,2 m |



|           |                                                                                     |                                                                                            |                                                                                            |                                                                                            |                                                                                          |                                                                                               |                                                                                              |                                                                                                   |                                                                                           |                                                                                           |                                                                                              |                                                                                                |                                                                                             |                                                                                                              |                                                                                                              |
|-----------|-------------------------------------------------------------------------------------|--------------------------------------------------------------------------------------------|--------------------------------------------------------------------------------------------|--------------------------------------------------------------------------------------------|------------------------------------------------------------------------------------------|-----------------------------------------------------------------------------------------------|----------------------------------------------------------------------------------------------|---------------------------------------------------------------------------------------------------|-------------------------------------------------------------------------------------------|-------------------------------------------------------------------------------------------|----------------------------------------------------------------------------------------------|------------------------------------------------------------------------------------------------|---------------------------------------------------------------------------------------------|--------------------------------------------------------------------------------------------------------------|--------------------------------------------------------------------------------------------------------------|
| XTJ 43+/C |  |  41,4 m |  15,2 m |  500 kg |  660° |  240x70 cm |  90°+80° |  3,64-5,23 m |  23% |  38% |  2 km/h |  10900 kg |  75 kN |  3,51 kN/m <sup>2</sup> |  5,39 kN/m <sup>2</sup> |
|-----------|-------------------------------------------------------------------------------------|--------------------------------------------------------------------------------------------|--------------------------------------------------------------------------------------------|--------------------------------------------------------------------------------------------|------------------------------------------------------------------------------------------|-----------------------------------------------------------------------------------------------|----------------------------------------------------------------------------------------------|---------------------------------------------------------------------------------------------------|-------------------------------------------------------------------------------------------|-------------------------------------------------------------------------------------------|----------------------------------------------------------------------------------------------|------------------------------------------------------------------------------------------------|---------------------------------------------------------------------------------------------|--------------------------------------------------------------------------------------------------------------|--------------------------------------------------------------------------------------------------------------|

90°+80°

Available power options:

**BI-ENERGY** (DIESEL+AC)

**ECO** (AC+BATTERY)

Characteristics and technical data are informative only and subjected to change without notice.

Palazzani Industrie S.p.A.

Via del Pavione, 4 - 25050 - Paderno F.C. (BS) - Italy

Tel. (+39) 0306857073

info@palazzani.it

www.palazzani.it

