













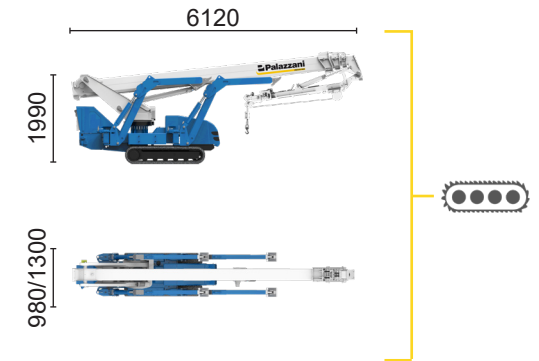
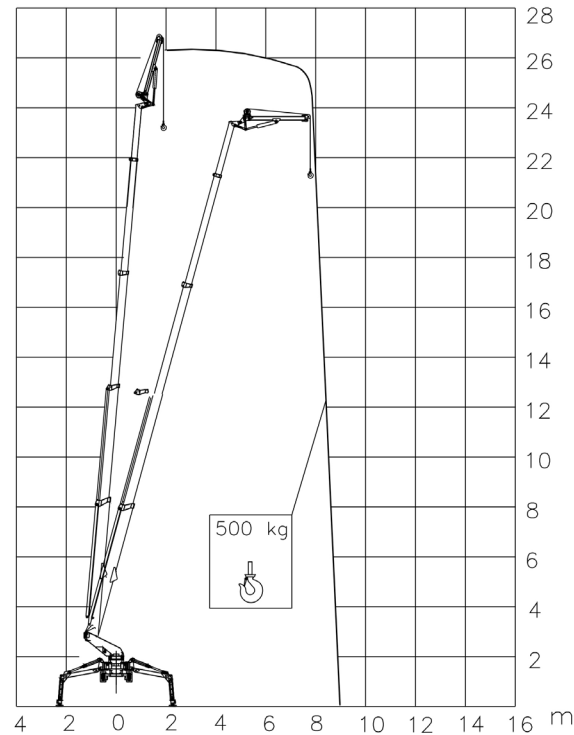









HYBRID²

 Diesel
10,6 kW

 Inverter actuated
Electric motor
5,5 kW

 Lithium iron
phosphate battery
LiFePO4 - 10,7 kWh
(48 V - 210 Ah)



															
TSJ 27/C		25,5 m	9 m	500 kg	660°	180x70 cm	90°+80°	2,86-4,79 m	44%	42%	1,2 km/h	4950 kg	29 kN	2,1 kN/m ²	4,49 kN/m ²

Available power options:
BI-ENERGY (DIESEL+AC)
ECO (AC+BATTERY)

The technical data may deviate +/- 3% from the specified values.
 Characteristics and technical data are informative only and subjected to change without notice.

Palazzani Industrie S.p.A.
 Via del Pavione, 4 - 25050 - Paderno F.C. (BS) - Italy
 Tel. (+39) 0306857073
 info@palazzani.it
 www.palazzani.it

