

# Palift **TZ 330+** SPIDER LIFT

PALAZZANI



**ECO**

---

 Inverter actuated  
Electric motor  
16 kW

---

 Lithium iron  
phosphate battery  
LiFePO4 - 21,5 kWh  
(48 V - 420 Ah)

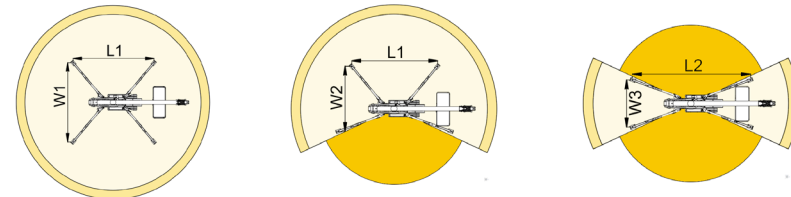
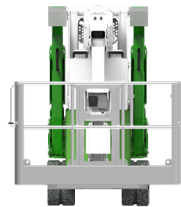
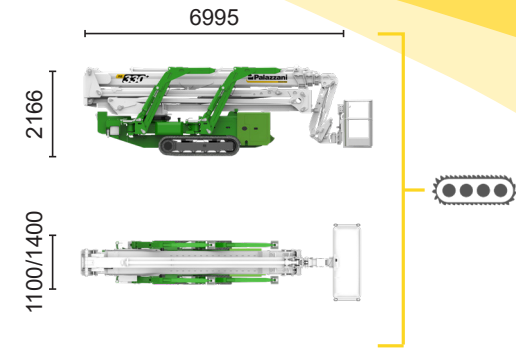
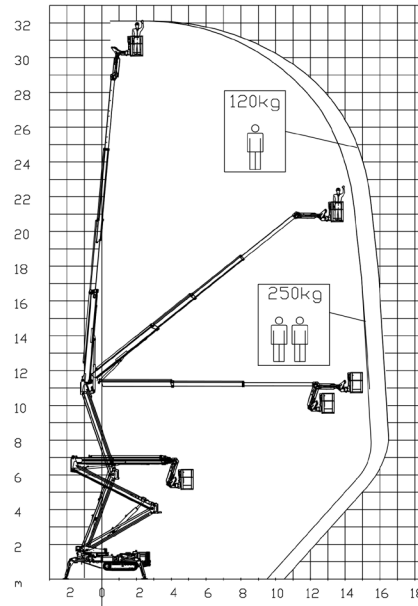

15,4 m	16,4 m	9,5 m	L1	L2	W1	W2	W3
250 kg	120 kg	250/120 kg	4725 mm	6170 mm	4910 mm	4020 mm	3130 mm

TZ 330+/C  32 m 16,4 m 250 kg 360° 180x70 cm 90°+90° 3,13-4,91 m 18% 32% 2,4 km/h 7200 kg 49 kN 3,1 kN/m2 5,72 kN/m2

Available power options:  
**BI-ENERGY** (DIESEL+AC)  
**HYBRID** (DIESEL+AC+BATTERY)

The technical data may deviate +/- 3% from the specified values.  
 Characteristics and technical data are informative only and subjected to change without notice.

Palazzani Industrie S.p.A.  
 Via del Pavione, 4 - 25050 - Paderno F.C. (BS) - Italy  
 Tel. (+39) 0306857073  
 info@palazzani.it  
 www.palazzani.it



CE NC 933 A 24