











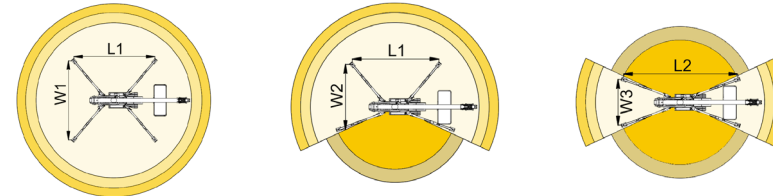
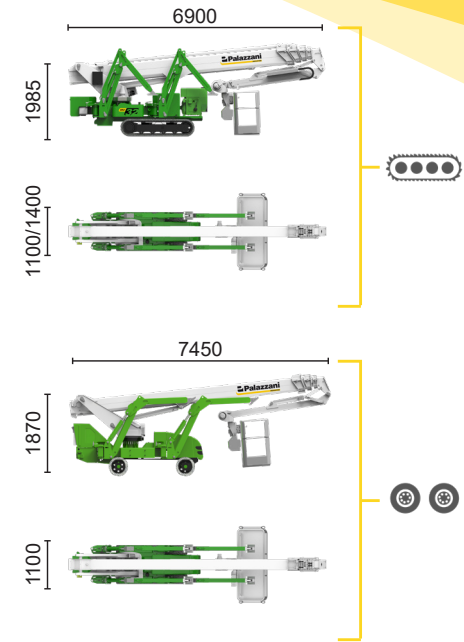
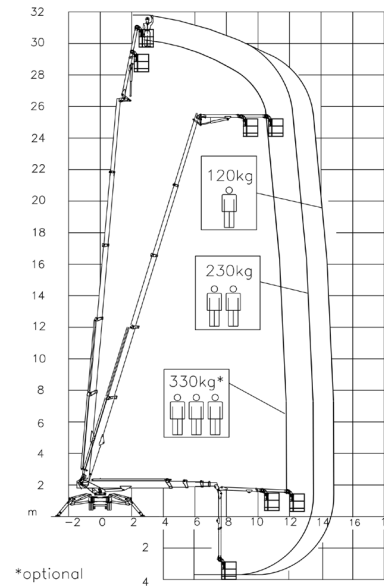











ECO

 Inverter actuated
Electric motor
16 kW

 Lithium iron
phosphate battery
LiFePO4 - 21,5 kWh
(48 V - 420 Ah)



11,6 m	13,3 m	14,3 m	8 m	9,6 m	L1	L2	W1	W2	W3
330 kg*	230 kg	120 kg	330 kg*	120/230 kg	5125 mm	6460 mm	4760 mm	3785 mm	2820 mm

															
XTJ 32/C		32 m	14,3 m	330 kg*	660°	180x70 cm	90°+80°	2,82-4,76 m	16%	32%	1,2 km/h	5940 kg	35 kN	2,43 kN/m2	4,78 kN/m2
XTJ 32/R		32 m	14,3 m	330 kg*	660°	180x70 cm	90°+80°	2,82-4,76 m	16%	18%	1,2 km/h	5940 kg	35 kN	2,43 kN/m2	4,78 kN/m2

Available power options:

 **BI-ENERGY** (DIESEL+AC)

The technical data may deviate +/- 3% from the specified values.

Characteristics and technical data are informative only and subjected to change without notice.

Palazzani Industrie S.p.A.

Via del Pavione, 4 - 25050 - Paderno F.C. (BS) - Italy

Tel. (+39) 0306857073

info@palazzani.it

www.palazzani.it



NC 937 A 24